



FABRIKA REZNOG ALATA

ČAČAK - SRBIJA



KATALOG PROIZVODA

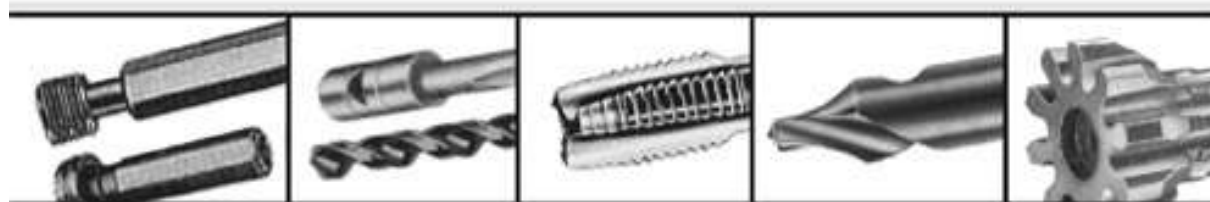

2012.











	Strana
• ALATI ZA BUŠENJE I OBRADU RUPE	3
• ALATI ZA GLODANJE	11
• <i>ALATI ZA IZRADU UNUTRAŠNJEG NAVOJA</i>	16
• <i>ALATI ZA IZRADU SPOLJAŠNJEG NAVOJA</i>	23
• <i>ALATI ZA OZUBLJENJE</i>	30
• <i>ALATI SA TVRDIM METALOM</i>	33
• <i>ALATI ZA KONTROLU I MERENJE</i>	41
• <i>ALATI ZA OBLIKOVANJE I OBRADU DEFORMACIJOM</i>	44
• <i>SPECIJALNI ALATI</i>	46
• <i>PRIBORI I UREĐAJI</i>	48
• <i>MAŠINE</i>	50
• <i>KONTAKT</i>	

















NAZIV	STANDARD	K.Br.	SLIKA	DIMENZIJA
-------	----------	-------	-------	-----------

HSS* HSS-EC_o *TiN

ZABUŠIVAČI 60°, oblik desnorezni, HSS A,	JUS K.D3.061 DIN 333	2.001		0.5 - 12.3
ZABUŠIVAČI 60°/120° oblik desnorezni, HSS B	JUS K.D3.062 DIN 333	2.002		1.0 - 10.0
ZABUŠIVAČI 60°, oblik desnorezni, HSS R,	JUS K.D3.061 DIN 333	2.003		0.5 - 12.5
SPIRALNE BURGIJE sa valjkastom držkom vrlo kratke desnorezne, HSS TIP N	JUS K.D3.019 DIN 1897	2.015		1.0 - 40.0
SPIRALNE BURGIJE sa aljkastom držkom vrlo kratke levorezne, HSS TIP N	JUS K.D3.019 DIN 1897	2.016		1.0 - 40.0
SPIRALNE BURGIJE sa valjkastom držkom kratke desnorezne, HSS TIP N	JUS K.D3.020 DIN 338	2.017		0.75 - 20.0
SPIRALNE BURGIJE sa valjkastom držkom kratke desnorezne, HSS.E TIP T	JUS K. D3.020 DIN 338	2.018		0.75 - 20.0

SPIRALNE BURGIJE sa valjkastom drškom kratk desnarezne, HSS TIP M	JUS K.D3.020 DIN 338	2.019		0.75 - 20.0
SPIRALNE BURGIJE sa valjkastom drškom duge desnarezne, HSS TIP N	JUS K.D3.02 DIN 340	2.022		1.0 - 31.5
SPIRALNE BURGIJE sa valjkastom drškom duge desnarezne, HSS.E TIP T	JUS K.D3.021 DIN 340	2.023		1.0 - 31.5
SPIRALNE BURGIJE sa valjkastom drškom duge desnarezne, HSS TIP M	JUS K.D3.021 DIN 340	2.024		1.0 - 31.5
SPIRALNE BURGIJE sa valjkastom drškom desnarezne za čelike do 1000 daN/mm ² TIP GMS	JUS K.D3.021 DIN 340	2.086		2.0 - 20.0
SPIRALNE BURGIJE sa valjkastom drškom desnarezne, HSS TIP GM	JUS K.D3.021 DIN 340	2.025		2.0 - 20.0
SPIRALNE BURGIJE sa valjkastom drškom extra duge desnarezne, HSS.E TIP N	JUS K.D3.045 DIN 1869	2.026		2.0 - 10
SPIRALNE BURGIJE sa morze-koničnom drškom desnarezne, HSS, TIP N	JUS K.D3.022 DIN 345	2.050		3.0 - 100

SPIRALNE BURGIJE sa morze-koničnom drškom desnorezne, HSS.E, TIP T	JUS K.D3.022 DIN 345	2.051		30 - 100
SPIRALNE BURGIJE sa morze-koničnom drškom, desnorezne, HSS, TIP M	JUS K.D3.022 DIN 345	2.052		3.0 - 100
SPIRALNE BURGIJE sa morze-koničnom drškom, ojačanom desnorezne, HSS, TIP N	JUS K.D3.023 DIN 346	2.053		12.0 - 76.0
SPIRALNE BURGIJE sa morze-koničnom drškom, za manganske čelike, TIP TS	JUS K.D3.023 DIN 346	2.088		5.0 - 50.0
SPIRALNE BURGIJE sa morze-koničnom drškom, duge desnorezne, HSS, TIP N	JUS K. D3.024 DIN 341	2.054		5.0 - 50.0
SPIRALNE BURGIJE sa morze-koničnom drškom, desnorezne, HSS, TIP GM	JUS K.D3.024 DIN 341	2.055		5.0 - 50.0
SPIRALNE BURGIJE sa morze-koničnom drškom, extra duge desnorezne, HSS.E TIP N	JUS K. D3.046 DIN 1870	2.056		8.0 - 50.0
SPIRALNE BURGIJE KONIČNE sa valjkastom drškom, za čivije, konus 1 : 50 desnorezne, HSS, TIP N	DIN 1898	2.070		1.0 - 20.0
SPIRALNE BURGIJE KONIČNE sa morze-koničnom drškom, za čivije, konus 1 : 50 desnorezne, HSS, TIP N	DIN 1898	2.071		5.0 - 50.0

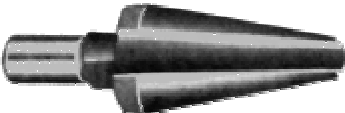
SPIRALNE BURGIJE STEPENASTE sa valjkastom drškom, za fini upust 90 ⁰ , po DIN-u 74 desnorezne, HSS	DIN 8374	2.080		3.2 - 10.5 6.0 - 19.0
SPIRALNE BURGIJE STEPENASTE sa morze-koničnom drškom za sred. upust 90 ⁰ , po DIN-u 74 desnorezne, HSS	DIN 8375	2.081		5.5 - 11.0 11.0 - 21.5
SPIRALNE BURGIJE STEPENASTE sa valjkastom drškom, za srednji upust 180 ⁰ , po DIN-u 74, desnorezne, HSS	DIN 8376	2.082		3.4 - 11.0 6.0 - 18.0
SPIRALNE BURGIJE STEPENASTE sa morze-koničnom drškom za srednji upust 180 ⁰ po DIN-u 74, desnorezne, HSS	DIN 8377	2.083		5.5 - 22.0 10.0 - 33.0
SPIRALNE BURGIJE STEPENASTE sa valjkastom drškom, za upust 90 ⁰ , za navojnu rupu, desnorezne, HSS	DIN 8378	2.084		2.5 - 10.2 3.4 - 13.5
SPIRALNE BURGIJE STEPENASTE sa morze-koničnom drškom, za upust 90 ⁰ , za navojnu rupu, desnorezne, HSS	DIN 8379	2.085		6.8 - 17.5 9.0 - 22.0
KONIČNE BURGIJE sa valjkastom drškom, za izradu otvora u materijalima manjih debljina, desnorezne, HSS		2.100		3.4 - 46.0 14.0 - 60.0

<p>BURGIJE STEPENASTE sa valjkastom drškom za izradu otvora u materijalima debljine do 10 mm, oblik ABC desnoredne, HSS</p>		2.101		5.5 - 8.0 35.5 - 38.0
<p>NOSAČI PLJOSNATIH BURGIJA sa morze-koničnom drškom, kratki</p>		2.111		25 - 140
<p>NOŽEVI ZA PLJOSNATE BURGIJE za dudoke otvore desnoredni, HSS</p>		2.114		25 - 140
<p>SPIRALNI UPUŠTAČI sa valjkastom drškom desnoredni, HSS</p>	JUS K.D3.300 DIN 344	2.200		5.5 - 20.0
<p>SPIRALNI UPUŠTAČI sa morze-koničnom drškom, desnoredni, HSS</p>	JUS K.D3.301 DIN 343	2.201		9.0 - 50.0
<p>SPIRALNI UPUŠTAČI sa morze-koničnom drškom za zakovice sa upuštenom glavom desnoredni, HSS</p>	JUS K.D3.302 DIN 1863	2.202		14.5 - 51.0
<p>ČEONI UPUŠTAČI sa morze-koničnom drškom, sa izmenljivom vojicom, za upuste prema DIN-u 74 desnoredni, HSS</p>	JUS K.D3.311 DIN 375	2.221		15.0 - 61.0
<p>KONIČNI UPUŠTAČI 60° oblik A, B, C, D desnoredni, HSS</p>	JUS K.D3.321 DIN 334	2.230		8.0 - 80.0
<p>KONIČNI UPUŠTAČI 90° oblik A, B, C, D, desnoredni, HSS</p>	JUS K. D3.323 DIN 335	2.231		8.0 - 80.0

<p>KONIČNI UPUŠTAČI 120° oblik A, B desnorezni, HSS</p>	<p>JUS K.D3.326 DIN 347</p>	<p>2.232</p>		<p>16.0 - 40.0</p>
<p>MAŠINSKI NASADNI UPUŠTAČI sa koničnom rupom 1:30 desnorezni, HSS</p>	<p>JUS K.D3.340 DIN 222</p>	<p>2.240</p>		<p>25.0 - 100.0</p>
<p>KONIČNI NASADNI UPUŠTAČI za ventilska sedišta 15°/30° desnorezni, HSS</p>		<p>2.250</p>		<p>24.0 - 60.0</p>
<p>KONIČNI NASADNI UPUŠTAČI za ventilska sedišta 45° desnorezni, HSS</p>		<p>2.251</p>		<p>24.0 - 60.0</p>
<p>KONIČNI NASADNI UPUŠTAČI za ventilska sedišta 75° desnorezni, HSS</p>		<p>2.252</p>		<p>28.0 - 58.0</p>
<p>KONIČNI NASADNI UPUŠTAČI za ventilska sedišta 15°, 30°, 45° desnorezni, HSS</p>		<p>2.253</p>		<p>32.0 - 58.0</p>
<p>ELASTIČNI UPUŠTAČI sa morze-koničnom drškom oblik B, za obaranje ivica na nepristupačnim mestima, desnorezni, HSS</p>		<p>2.261</p>		<p>7.0 - 38.0</p>
<p>KONIČNI UPUŠTAČI sa valjkastom drškom oblik A, sa poprečnom rupom za obaranje ivica otvora sa uglom vrha 60° i 90° desnorezni, HSS</p>		<p>2.262</p>		<p>10.0 - 64.0</p>

<p>RUČNI RAZVRTAČI sa valjkastom drškom sa pravim i spiralnim žlebovima desnorezni, HSS</p>	<p>JUS K.D3.121 DIN 206</p>	<p>2.300</p>		<p>1.5 - 50.0</p>
<p>MAŠINSKI RAZVRTAČI sa morze-koničnom drškom sa pravim i spiralnim žlebovima desnorezni, HSS</p>	<p>JUS K.D3.132 DIN 208</p>	<p>2.301</p>		<p>5.0 - 50.0</p>
<p>MAŠINSKI RAZVRTAČI sa valjkastom drškom sa pravim i spiralnim žlebovima desnorezni, HSS</p>	<p>JUS K.D3.131 DIN 212</p>	<p>2.302</p>		<p>1.4 - 20.0</p>
<p>RUČNI RAZVRTAČI sa valjkastom drškom sa pomožnim noževima desnorezni, HSS</p>		<p>2.304</p>		<p>7.0 - 100.0</p>
<p>KONIČNI RAZVRTAČI sa valjkastom drškom sa pravim i spiralnim žlebovima za NPT navoj, konus 1:16 desnorezni, HSS</p>		<p>2.307</p>		<p>1/8" - 2"</p>
<p>KONIČNI RAZVRTAČI sa valjkastom drškom sa pravim i spiralnim žlebovima, za konus 1:50 desnorezni, HSS</p>	<p>JUS K.D3.180 DIN 9</p>	<p>2.308</p>		<p>2.0 - 50.0</p>
<p>MAŠINSKI RAZVRTAČI sa morze-konusnom drškom za rupe zakovica, desnorezni, HSS</p>	<p>JUS K.D3.201 DIN 311</p>	<p>2.309</p>		<p>6.4 - 50.0</p>

<p>KONIČNI RAZVRTAČI sa valjkastom drškom oblik A, B, C za morze-konus desnorezni, HSS</p>	<p>DIN 204</p>	<p>2.310</p>		<p>MK 0 - MK 6</p>
<p>KONIČNI RAZVRTAČI sa morze-konusnom drškom, oblik A, B, C za morze-konus desnorezni, HSS</p>	<p>DIN 1895</p>	<p>2.311</p>		<p>MK 0 - MK 6</p>
<p>MAŠINSKI NASADNI RAZVRTAČI sa koničnom rupom 1:30, sa pravim i spiralnim, žlebovima desnorezni, HSS</p>	<p>JUS K. D3.170 DIN 219</p>	<p>2.312</p>		



NAZIV	STANDARD	K.Br.	SLIKA	DIMENZIJA
HSS* HSS-EC05* HSS EC08* TiN				
VRETENASTA GLODALA sa valjkastom drškom kratka, TIP N	JUS K.D2.090 DIN 844-A-K DIN 844-B-K DIN 844-D-K	3.001 3.030 3.031		2.0 - 36.0
VRETENASTA GLODALA sa valjkastom drškom duga, TIP N	JUS K.D2.090 DIN 844-A-L DIN 844-B-L DIN 844-D-L	3.011 3.032 3.033		2.0 - 36.0
VRETENASTA GLODALA sa morze-koničnom drškom kratka, TIP N	JUS K.D2.092 DIN 845-B-K	3.002		10.0 - 63.0
VRETENASTA GLODALA sa morze-koničnom drškom duga, TIP N	JUS K.D2.092 DIN 845-B-L	3.014		10.0-63.0
VRETENASTA GLODALA sa valjkastom drškom DIN 2080	JUS K.D2.093 DIN 2328	3.006		32.0-80.0
VRETENASTA GLODALA sa valjkastom drškom kratka sa lomačem strugotine, TIP NR	JUS K.D2.095 DIN 844-B-K	3.034		7.0-36.0
VRETENASTA GLODALA sa valjkastom drškom kratka sa lomačem strugotine, TIP NF	JUS K.D2.095 DIN 844-B-K	3.017		7.0-36.0
VRETENASTA GLODALA sa valjkastom drškom duga sa lomačem strugotine, TIP NR	JUS K.D2.095 DIN 844-L	3.012		7.0-36.0

VRETENASTA GLODALA sa valjkastom drškom duga sa lomačem strugotine, TIP NF	JUS K.D2.095 DIN 844-L	3.013		7.0-36.0
VRETENASTA GLODALA sa morze-koničnom drškom kratka sa lomačem strugotine, TIP NR, TIP NF	JUS K.D2.096 DIN 845-B-K	3.004 3.035		10.0-63.0
VRETENASTA GLODALA sa morze-koničnom drškom kratka sa lomačem strugotine, TIP NR, TIP NF	JUS K.D2.096 DIN 845-C-K	3.018 3.036		32.0-63.0
VRETENASTA GLODALA sa morze-koničnom drškom duga sa lomačem strugotine, TIP NR, TIP NF	JUS K.D2.096 DIN 845-C-L	3.015 3.037		10.0-63.0 32.0-63.0
VRETENASTA GLODALA sa morze-koničnom drškom duga sa lomačem strugotine, TIP NR, TIP NF	JUS K.D2.096 DIN 845-B-L	3.016 3.038		10.0-63.0
VRETENASTA GLODALA sa konusnom drškom DIN 2080 sa lomačem strugotine, TIP NR, TIP NF	JUS K.D2.097 DIN 2328	3.005 3.039		32.0-80.0
GLODALA ZA ŽLEBOVE sa valjkastom drškom	JUS K.D2.110 DIN 327 A-K	3.020		2.0-36.0
GLODALA ZA ŽLEBOVE sa valjkastom drškom spiralni žljeb	JUS K.D2.110 DIN 327 B	3.021		2.0-36.0
GLODALA ZA ŽLEBOVE sa valjkastom drškom spiralni žljeb sa zubima do centra		3.112		2.0-36.0

GLODALA ZA ŽLEBOVE sa morze-koničnom drškom sa navojem u dršci	JUS K.D2.113 DIN 326 C	3.022		10.0-63.0
GLODALA ZA ŽLEBOVE sa morze-koničnom drškom sa navojem u dršci spiralni žleb	JUS K.D2.113 DIN 326 D	3.023		10.0-63.0
GLODALA ZA ŽLEBOVE za lake metale sa jednim zubom		3.113		3.0-12.0
GLODALA ZA T ŽLEBOVE sa valjkastom drškom sa ukrštenim zubima	JUA K.D2.138 DIN 851 A	3.024		prečnik 11.0-60.0 širina 4.0-28.0
GLODALA ZA T ŽLEBOVE sa morze-koničnom drškom sa ukrštenim zubima	JUS K.D2.140 DIN 851 B	3.025		prečnik 18.0-40.0 širina 8.0-18.0
GLODALA ZA T ŽLEBOVE sa morze-koničnom drškom sa ukrštenim zubima	JUS K.D2.140 DIN 851 B	3.027		prečnik 50.0-95.0 širina 22.0-44.0
GLODALA ZA ŽLEBOVE sa valjkastom drškom sa pravim zubima za segmentne klinove	JUS K.D2.141 DIN 850 A	3.026		prečnik 4.5-45.5 širina 1.0-10.0
GLODALA ZA ŽLEBOVE sa valjkastom drškom sa ukrštenim zubima za segmentne klinove	JUS K.D2.141 DIN 850 B	3.028		prečnik 4.5-45.5 širina 1.0-10.0
UGAONA GLODALA sa valjkastom drškom oblik A	JUS K.D2.145 DIN 1833 A	3.040		prečnik 16.0-25.0 širina 4.0-11.0
UGAONA GLODALA sa valjkastom drškom oblik B	JUS K.D2.145 DIN 1833 B	3.041		prečnik 16.0-25.0 širina 4.0-11.0
VRETENASTA GLODALA sa valjkastom drškom za kovačke kalupe	JUS K.D2.200 DIN 1889 AA	3.050		6.0-50.0

VRETENASTA GLODALA sa valjkastom drškom za kovačke kalupe sa loptastim čelom	JUS K.D2.204 DIN 1889 BA	3.054		6.0-50.0
VRETENASTA GLODALA sa morze-koničnom drškom za kovačke kalupe	JUS K.D2.201 DIN 1889 C	3.051		10.0-40.0
VRETENASTA GLODALA sa morze-koničnom drškom za kovačke kalupe sa loptastim čelom	JUS K.D2.201 DIN 1889 D	3.055		10.0-40.0
VRETENASTA GLODALA KONIČNA sa valjkastom drškom za kovačke kalupe sa ravnim čelom	JUS K.D2.202 DIN 1889 EA	3.058		1:6 2.5-12 1:10 2.5-16 1:20 4-20
VRETENASTA GLODALA KONIČNA sa valjkastom drškom za kovačke kalupe sa loptastim čelom	JUS K.D2.202 DIN 1889 FA	3.057		1:6 2.5-12 1:10 2.5-16 1:20 4-20
VRETENASTA GLODALA KONIČNA sa valjkastom drškom za kovačke kalupe specijalne namene		3.056		1°30 3° 5°
VALJKASTA GLODALA	JUS K.D2.020 DIN 884	3.060		50.0-100.0
ČEONA NASADNA GLODALA sa poprečnim žlebom	JUS K.D2.022 DIN 1880	3.063		40.0-160.0
ČEONA NASADNA GLODALA sa uzdužnim žlebom		3.062		40.0-160.

ČEONA NASADNA GLODALA sa poprečnim žlebom za tešku obradu TIP NR, TIP NF	JUS K.D2.022 DIN 1880	3.065 3.066		40.0-160.0
KOTURASTA GLODALA sa ukrštenim zubima	JUS K.D2.040 DIN 885A	3.070		50.0-200 4.0-40.0
KOTURASTA GLODALA sa pravim zubima	JUS K.D2.040B DIN 885B	3.071		50.0-200 40-40.0
UGAONA GLODALA jednostrana	JUS K.D2.070 DIN 842A	3.081		40.0-160.0
UGAONA GLODALA simetrična	JUS K.D2.071 DIN 847	3.082		50.0-100.0
UGAONA GLODALA dvostrana	JUS K.D2.075 DIN 1823B	3.086		50.0-63.0
POLUKRUŽNA UDUBLJENA GLODALA desnorezna	JUS K.D2.080 DIN 855A	3.100		R1-20
POLUKRUŽNA ISPUPČENA GLODALA desnorezna	JUS K.D2.081 DIN 856	3.101		R1-20



NAZIV	STANDARD	K.Br.	SLIKA	DIMENZIJA
HSS* HSS-EC_o *TiN				
UREZNICI U GARNITURI od 3 komada za M navoj tol. polje 6H,HSS	DIN 352	4.001		1.0-52.0
UREZNICI U GARNITURI od 3 komada za UNC navoj tol. polje 2B,HSS	DIN 352	4.002		N ^o 4.0-40.0 1"-8
UREZNICI U GARNITURI od 2 komada za M fini navoj tol. polje 6H,HSS	DIN 2181	4.010		1.0-52.0
UREZNICI U GARNITURI od 2 komada za UNF navoj tol. polje 2B,HSS	DIN 2181	4.011		N ^o 4.0-40.0 1 1/2"-12.0
UREZNICI U GARNITURI od 2 komada za G navoj DIN - ISO 228,HSS	DIN 5157	4.012		1/16"-4"
UREZNICI U GARNITURI od 2 komada za Rp navoj DIN 2999,HSS	DIN 5157	4.013		1/16"-4"
UREZNICI KONIČNOG NAVOJA za NPT navoj (1 : 16) ASA.B.2.1,HSS		4.020		1/16"-27.0 2"-11.5
UREZNICI MAŠINSKI KRATKI oblik B za M navoj tol.polje 6H,HSS	DIN 352	4.030		2.5-52.0

<p>UREZNICI MAŠINSKI KRATKI za UNC navoj tol.polje 2B oblik B,HSS</p>	<p>DIN 352</p>	<p>4.031</p>		<p>N⁰4.0-40.0 1"-8</p>
<p>UREZNICI MAŠINSKI KRATKI sa spiralnim žlebovima spirala desna 15⁰ za M navoj tol.polje 6H oblik C,HSS</p>	<p>DIN 352</p>	<p>4.032</p>		<p>2.0-52.0</p>
<p>UREZNICI MAŠINSKI KRATKI sa spiralnim žlebovima spirala leva 15⁰ za M navoj tol.polje 6H oblik D,HSS</p>	<p>DIN 352</p>	<p>4.033</p>		<p>2.0-52.0</p>
<p>UREZNICI MAŠINSKI za M navoj oblik A, B, C tol.polje 6H,HSS</p>	<p>DIN 376</p>	<p>4.040</p>		<p>1.6-52.0</p>
<p>UREZNICI MAŠINSKI za UNC navoj oblik A, B, C tol.polje 2B,HSS</p>	<p>DIN 374 DIN376</p>	<p>4.041</p>		<p>N⁰4.0-40.0 1"-8</p>
<p>UREZNICI MAŠINSKI za Re (Pg) navoj DIN 40430 oblik A, B, C,HSS</p>	<p>DIN 374 DIN 376</p>	<p>4.042</p>		<p>7.0-48.0</p>
<p>UREZNICI MAŠINSKI za M fini navoj oblik A, B, C tol.polje 6H,HSS</p>	<p>DIN 374</p>	<p>4.043</p>		<p>1.6-52.0</p>

UREZNICI MAŠINSKI za UNF navoj oblik A, B, C tol.polje 2B,HSS	DIN 374 DIN 376	4.044		N ^o 4.0-48.0 1"-12.0
UREZNICI MAŠINSKI za G navoj DIN - ISO 228 oblik A, B, C,HSS	DIN 5156	4.045		1/16"-2"
UREZNICI MAŠINSKI za Rp navoj DIN 2999 oblik A, B, C,HSS	DIN 5156	4.046		1/16"-2"
UREZNICI MAŠINSKI za M navoj 6H oblik A, B, C,HSS	ISO 529	4.047		3.0-68.0
UREZNICI MAŠINSKI za M fini navoj oblik A, B, C tol.polje 6H,HSS	ISO 529	4.048		3.0-52.0
UREZNICI MAŠINSKI sa spiralnim žlebovima spirala desna 15 ^o i 35 ^o za M navoj oblik C tol.polje 6H,HSS	DIN 376	4.060		2.0-52.0
UREZNICI MAŠINSKI sa spiralnim žlebovima spirala desna 15 ^o i 35 ^o za M fini navoj oblik C tol.polje 6H,HSS	DIN 374	4.061		2.0-52.0
UREZNICI MAŠINSKI sa spiralnim žlebovima spirala leva 15 ^o za M navoj oblik D tol.polje 6H,HSS	DIN 376	4.062		2.0-52.0

<p>UREZNICI MAŠINSKI sa spiralnim žlebovima spirala leva 15° za M navoj oblik D tol.polje 6H,HSS</p>	<p>DIN 374</p>	<p>4.063</p>		<p>2.0-52.0</p>
<p>UREZNICI MAŠINSKI sa ojačanom drškom za M navoj oblik A, B, C tol.polje 6H,HSS</p>	<p>DIN 371</p>	<p>4.070</p>		<p>1.0-10.0</p>
<p>UREZNICI MAŠINSKI sa ojačanom drškom za M navoj oblik A, B, C tol.polje 6H,HSS</p>	<p>ISO 529</p>	<p>4.071</p>		<p>1.0-10.0</p>
<p>UREZNICI MAŠINSKI sa ojačanom drškom za M fini navoj oblik A, B, C tol.polje 6H,HSS</p>	<p>ISO 529</p>	<p>4.072</p>		<p>1.0-10.0</p>
<p>UREZNICI MAŠINSKI sa ojačanom drškom spiralnim žlebovima spirala desna 15° i 35° za M navoj oblik C tol.polje 6H,HSS</p>	<p>DIN 371</p>	<p>4.080</p>		<p>2.0-10.0</p>
<p>UREZNICI MAŠINSKI sa ojačanom drškom spiralnim žlebovima spirala leva 15° za M navoj oblik D tol.polje 6H,HSS</p>	<p>DIN 371</p>	<p>4.081</p>		<p>2.0-10.0</p>
<p>UREZNICI MAŠINSKI sa ojačanom drškom za lake metale spirala desna 45° za M navoj oblik C tol.polje 6H,HSS</p>	<p>DIN 371</p>	<p>4.082</p>		<p>2.0-10.0</p>
<p>UREZNICI MAŠINSKI za lake metale spirala desna 45° za M navoj oblik C tol.pole 6H,HSS</p>	<p>DIN 376</p>	<p>4.083</p>		<p>2.0-24.0</p>

UREZNICI MAŠINSKI CONSTANT za M navoj oblik B tol.polje 6H,HSS	DIN 371 DIN 376	4.084		1.6-30.0
UREZNICI MAŠINSKI CONSTANT za UNC navoj oblik B tol.polje 2B,HSS	DIN 371 DIN 376	4.085		N ⁰ 1.0-64.0 1"-8
UREZNICI MAŠINSKI "CONSTANT EXTRA" za M navoj oblik B tol.polje 6H,HSS	DIN 371 DIN 376	4.086		2.0-30.0
UREZNICI MAŠINSKI sa izvajenim zubima za M navoj oblik A, B, C tol.polje 6H,HSS	DIN 371 DIN 376	4.100		3.0-36.0
UREZNICI MAŠINSKI sa izvajenim zubima za NPT navoj (1 : 16) ASA B.2.1,HSS		4.101		1/16"-2"
UREZNICI MAŠINSKI za Rd navoj DIN 405 oblik C,HSS		4.110		8.0-20.0
UREZNICI MAŠINSKI za Tr navoj tol.polje 7H,HSSE		4.111		10.0-52.0
UREZNICI MAŠINSKI u garnituri od 2 komada za Tr navoj tol.polje 7H,HSSE		4.112		10.0-40.0
UREZNICI MAŠINSKI u garnituri od 3 komada za Tr navoj tol.polje 7H,HSSE		4.113		10.0-52.0
UREZNICI ZA NAVRTKE za M navoj tol.polje 6H,HSS	DIN 357	4.120		3.0-52.0

UREZNICI ZA NAVRTKE za M fini navoj tol.polje 6H,HSS	DIN 357	4.121		3.0-30.0
UREZNICI ZA NAVRTKE za UNC navoj tol.polje 2B,HSS	DIN 357	4.122		N ⁰ 4.0-40.0 1"-8
UREZNICI ZA NAVRTKE za G navoj DIN-ISO 228,HSS	DIN 357	4.123		1/8"-1 1/2"
UREZNICI ZA NAVRTKE "TANDEM" za M navoj tol.polje 6H,HSS	DIN 357	4.124		3.0-52.0
UREZNICI ZA NAVRTKE "TANDEM" za UNC navoj tol.polje 2B,HSS	DIN 357	4.125		N ⁰ 4.0-40.0 1"-8
UREZNICI ZA NAVRTKE "TANDEM" sa spiralnim žlebovima spirala leva 8 ⁰ za M navoj tol.polje 6H,HSS	DIN 357	4.126		3.0-52.0
UREZNICI ZA NAVRTKE "NUTAP" za M navoj tol.polje 6H,HSSE		4.127		2.6-33.0
UREZNICI ZA NAVRTKE "NUTAP" za UNC navoj tol.polje 2B,HSSE		4.128		N ⁰ 5.0-40.0 7/16-14
SPIRALNE BURGIJE- UREZNICI za M navoj tol.polje 6H,HSS		4.140		3.0-20.0
UTISKIVAČI NAVOJA sa ojačanom drškom za M navoj oblik A, C tol.polje 6H,HSS	DIN 371	4.150		3.0-10.0

UTISKIVAČI NAVOJA za M navoj oblik A, C tol.polje 6H,HSS	DIN 376	4.151		3.0-12.0
UTISKIVAČI NAVOJA za M fini navoj oblik A, C tol.polje 6H,HSS	DIN 374	4.152		3.0-20.0
OKRETAČI ZA UREZNIKE		4.200		N°1.0-4.0
OKRETAČI ZA UREZNIKE podešljivi		4.201		N°0-6.0
KOMPLET ALATA za M navoj M3 - M10		4.220		M3-M10
KOMPLET ALATA za M navoj M5 - M20		4.221		M5-M20
KOMPLET ALATA za UNC, UNF navoj 1/4" - 1"		4.222		1/4"-1"



NAZIV	STANDARD	K.Br.	SLIKA	DIMENZIJA
HSS* HSSE				
NAREZNICE OKRUGLE oblik A i B M navoj klasa 6g RUČNE MAŠINSKE LEP, KRI I LEP-KRI.	JUS K.D6.200 EN 22568 ISO 2568	5.001		1.6 - 68.0
NAREZNICE OKRUGLE oblik A i B M fini navoj RUČNE MAŠINSKE LEP, KRI I LEP-KRI.	JUS K.D6.201 EN 22568 ISO 2568	5.002		2.0 - 68.0
NAREZNICE OKRUGLE oblik A I B M konusni navoj konus 1 : 16 DUŽ,VIJKA N DUŽ,VIJKA K RUČNE MAŠINSKE KRI.	EN 22568 ISO 2568	5.003 5.004		5.0 - 60.0
NAREZNICE OKRUGLE oblik A i B UNC navoj klasa 2A RUČNE MAŠINSKE LEP, KRI i LEP-KRI.	EN 22568 ISO 2568	5.005		N ⁰ 1 - 64" 3" - 4"
NAREZNICE OKRUGLE oblik A i B, UNF navoj, UNEF navoj, UNS navoj, UN navoj klasa 2A RUČNE MAŠINSKE LEP, KRI i LEP- KRI.	EN 22568 ISO 2568	5.006 5.007 5.008 5.009		N ⁰ 1-72, 1 1/2"- 12 1/2"-32, 1 1/16"-18 N ⁰ 10-56, 3"-10 7/16-32, 3"-6

NAREZNICE OKRUGLE oblik A i B, NPSM navoj desnorezne klasa 2A RUČNE MAŠINSKE LEP, KRI i LEP-KRI.	EN 24231 ISO 4231	5.010		1/8" - 27 3" - 8"
NAREZNICE OKRUGLE oblik A i B desnorezne NPT navoj, NPTF navoj RUČNE MAŠINSKE KRI.	EN 2420 ISO 4230	5.011 5.012		1/16"-27, 3"-8 1/16"-27, 3"-8
NAREZNICE OKRUGLE oblik A i B, BSW navoj i BSF klasa med. RUČNE MAŠINSKE LEP, KRI i LEP-KRI.	EN 22568 ISO 2568	5.013 5.014		1/16"-60, 3"31/2 1/16"-32, 3"-5
NAREZNICE OKRUGLE oblik A i B BA NAVOJ klasa N (za galvansku zaštitu)	EN 22568 ISO 2568	5.017		N ⁰ -N ¹⁰
NAREZNICE OKRUGLE oblik A i B, G navoj klasa A RUČNE MAŠINSKE LEP, KRI i LEP-KRI.	EN 24231 ISO 4231	5.015		1/16" - 3"
NAREZNICE OKRUGLE oblik A i B, R navoj za DIN 3858 i DIN 2999 RUČNE MAŠINSKE KRI.	EN 24230 ISO 4230	5.016		1/16" - 3"
NAREZNICA OKRUGLA oblik A i B Re navoj (Pg) RUČNE MAŠINSKE LEP, KRI i LEP-KRI.	DIN 40434	5.018		7-48

NAREZNICE OKRUGLE oblik A i B, Tr navoj klasa 7c RUČNE MAŠINSKE LEP, KRI i LEP-KRI.	EN 22568 ISO 2568	5.019		8x1.5-32x6
NAREZNICE OKRUGLE oblik A i B, Rd navoj klasa 7h RUČNE MAŠINSKE LEP, KRI i LEP-KRI.	EN 22568 ISO 2568	5.020		8x1/10"- 32x1/8"
NAREZNICE OKRUGLE oblik A i B, Vn navoj RUČNE MAŠINSKE LEP, KRI i LEP-KRI.	EN 22568 ISO 2568	5.021		N ⁰ 5Vn- N ⁰ 12Vn
NAREZNICE OKRUGLE ZA AUTOMATE ZVONČASTE oblik B, M navoj klasa 6g LEP, LEP-KRI	EN 22568 ISO 2568	5.050		1,6 - 10
NAREZNICE OKRUGLE ZA AUTOMATE ZVONČASTE oblik B, M navoj sitni klasa 6g LEP, LEP-KRI	EN 22568 ISO 2568	5.051		2.0 - 10
NAREZNICE OKRUGLE ZA AUTOMATE ZVONČASTE oblik B, UNC navoj UNF, UNEF UNS, UN klasa 2A LEP, LEP-KRI	EN 22568 ISO 2568	5.052 5.053 5.054 5.055 5.056		No1-64;3/8"- 16 No1-72;3/8"- 24 1/2"-32;3/8"- 32 No10-56;5/8"- 18 5/16"-28;3/8"- 20
NAREZNICE OKRUGLE ZA AUTOMATE ZVONČASTE oblik B, NPSM navoj klasa 2A LEP, LEP-KRI	EN 24231 ISO 4231	5.057		1/8" - 27

NAREZNICE OKRUGLE ZA AUTOMATE ZVONČASTE oblik B, BSW navoj i BSF klasa med. LEP, LEP-KRI	EN 22568 ISO 2568	5.058 5.059		1/16"-60; 3/8"- 16 3/16"-32; 3/8"- 20
NAREZNICE OKRUGLE ZA AUTOMATE ZVONČASTE oblik B, G navoj klasa A LEP, LEP-KRI	EN 24231 ISO 4231	5.060		1/16"-1/8'
NAREZNICE OKRUGLE ZA AUTOMATE ZVONČASTE oblik B, Vn navoj LEP, LEP-KRI	EN 22568 ISO 2568	5.062		N ⁰ 5Vn-N ⁰ 9Vn
NAREZNICE OKRUGLE ZA AUTOMATE ZVONČASTE oblik B, Tr navoj klase 7e LEP, LEP-KRI	EN 22568 ISO 2568	5.063		8x1.5 10x1.5
NAREZNICE OKRUGLE ZA AUTOMATE sa čeonim otvorom za prihvatanje		5.075		N ⁰ 1-1' 1/16'-1' G1/16'-G3/4'
NAREZNICE OKRUGLE ZA AUTOMATE sa čeonim otvorom za prihvatanje SA ČEONIM ELIPSASTIM OLAKŠANJEM ZA ODVOD STRUGOTINE		5.076		1.6-26.5 N ⁰ 1-1' 1/16'-1' G1/16'; G3/4'
NAREZNICE OKRUGLE ZA AUTOMATE sa trapeznim urezom profila 60 ⁰ u pravcu zuba SA ČEONIM ELIPSASTIM OLAKŠANJEM ZA ODVOD STRUGOTINE		5.077		1.6-26.5 N ⁰ 1-1' 1/16'-1' G1/16'; G3/4'

NAREZNICE OKRUGLE PODEŠLJIVE otvorene, sa tetivnim vijkom za podešavanje	GGG D-296/a	5.103		1.6-39.0 N ⁰ 1-1 1/2' 1/16'-1 1/2' G1/16'-G1 1/4'
NAREZNICE OKRUGLE PODEŠLJIVE FRA - ACORN		5.106		1.6-39.0 N ⁰ 1-1 1/2' 1/16'-1 1/2' G1/16'-G1
NAREZNICE ŠESTOUGAONE M navoj, klasa 6g RUČNE MAŠINSKE LEP, KRI i LEP-KRI	DIN 382	5.125		1.6 - 68.0
NAREZNICE ŠESTOUGAONE UNC navoj UNF navoj klasa 2A RUČNE MAŠINSKE LEP, KRI i LEP-KRI	DIN 382	5.126 5.127		N ⁰ 1-64, 3"-4 N ⁰ 1-72; 1/2'-12
NAREZNICE ŠESTOUGAONE BSW navoj BSF navoj RUČNE MAŠINSKE LEP, KRI i LEP-KRI	DIN 382	5.128 5.129		1/16'-60; 3'-3 1/2 3/16-32; 3'- 5
NAREZNICE ŠESTOUGAONE G navoj klasa A RUČNE MAŠINSKE LEP, KRI i LEP-KRI	DIN 382	5.130		1/16" - 3"
OKRETAČI ZA NAREZNICE	EN 22568 ISO 2568	5.200		N ⁰ 0 - N ⁰ 20
VALJCI za valjanje navoja za protočno valjanje		5.300 5.303		M3 - M52
VALJCI za "Fette" glave za WAGNER glave za FRA glave		5.301		M2 - M54



SEGMENTI za valjanje navoja		5.302		120-140
PLOČE za valjanje navoja ravne sa uglom od 5° sa čela		5.325 5.326		16x45x12 150x530x90
PLOČE za valjanje vijaka za drvo i lim, ravne sa uglom od 5° sa čela		5.327 5.328		16x45x12 83x170x40
AKSIJALNE GLAVE za valjanje navoja		5.340		M5 - M48
TOČKIĆ za nareckivanje	DIN 403	5.360		1.6-10
GLODALA VALJKASTA za navoj, podbrušen profil	JUS.K.D2.129 DIN 852	5.375		korak navoja 0.5-3
GLODALA VALJKASTA za navoj, podbrušen profil sa ukopom sa čela	JUS K.D2.130 DIN 852	5.376		korak navoja 0.5-3
GLODALA za navoj, desnorezna sa valjkastom držkom podbrušen profil	JUS K.D2.131 DIN 887	5.377		korak navoja 0.5-3
GLODALA za navoj, desnorezna, sa Morze-koničnom držkom, podbrušen profil	JUS K.D2.132 DIN 888	5.378		korak navoja 0.5-3

GLODALA za navoj, za automate, (INDEX, TRAUB, GILDEMEISTER)		5.379		korak navoja 0.5-1
NOŽEVI NAVOJNI TANGENCIJALNI za " WAGNER GLAVE "		5.400		Z 16-Z 76
NOŽEVI NAVOJNI TANGENCIJALNI za PH(KOVO) glave		5.401		PH 1-PH 4
NOŽEVI NAVOJNI RADIJALNI sistem H (HERBERT, PITTLER, SCHUTTE)		5.402		H 1-5
NOŽEVI NAVOJNI RADIJALNI sistem G (GEOMETRIC)		5.403		F - V
NOŽEVI NAVOJNI RADIJALNI za ručne klupne RK		5.404		R.K 1-111
GLAVA ZA REZANJE CEVNOG NAVOJA FRA 1 RCN FRA 2 RCN		5.405 5.406		1/4"-1" 1/2"- 2"
NOŽEVI NAVOJNI OKRUGLI sa drškom za rupe		5.425		korak navoja 0.5-3.5
NOŽEVI NAVOJNI OKRUGLI nasadni za rupe		5.426		korak navoja 1.0-6.0

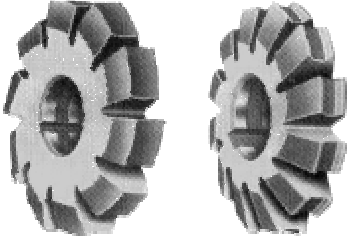
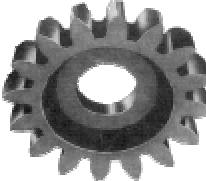

NAZIV	STANDARD	K.Br.	SLIKA	DIMENZIJA
HSS i HSS-E				
MODULNA ODVALNA GLODALA za cilindrične zupčanike sa pravim i kosim zupcima ugao zahvata 20° i 15° profil DIN 3972	DIN 8002 DIN 858	6.001		m1 - m18
MODULNA ODVALNA GLODALA za cilindrične zupčanike sa pravim i kosim zupcima ugao zahvata 20° i 15° profil DIN 58412	DIN 858	6.126		m0,25 - m1
GLODALA sa umetnutim zubima		6.125		m1-m12
MODULNA PLOČASTA GLODALA podstrugan profil za cilindrične zupčanike ugao zahvata 20° profil DIN 3972		6.002		m0.5-m9
PLOČASTA GLODALA za lančanike podstrugana profil po DIN-u 8198 za ozubljenje lančanika prema DIN-u 8196		6.050		N°1-N°5

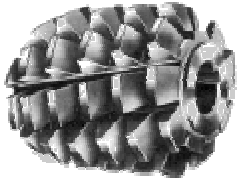
<p>PLOČASTA GLODALA za ožljebljena vratila bez bradice oblik A sa bradicom - oblik B za završnu obradu</p>	<p>JUS M.C1.420 JUS M.C1.421 DIN 5462 DIN 5463</p>	<p>6.075</p>		<p>50-95</p>
<p>PLOČASTA GLODALA za ožljebljena vratila bez bradice - oblik A sa bradicom - oblik B za završnu obradu za ožljebljena vratila</p>	<p>JUS M.C1.440 DIN 5471</p>	<p>6.076</p>		<p>50-80</p>
<p>PLOČASTA GLODALA za ožljebljena vratila bez bradice - oblik A sa bradicom - oblik B za završnu obradu za ožljebljena vratila</p>	<p>JUS M.C1.441 DIN 5472</p>	<p>6.077</p>		<p>60-95</p>
<p>ODVALNA GLODALA za ožljebljena vratila DIN 5480 DIN 5482</p>		<p>6.127 6.128</p>		<p>m0,6 - m10 m1,6 - m 2,25</p>
<p>KRUŽNI ZUPČASTI NOŽ sa drškom osnovni profil prema DIN-u 3972, DIN 5480</p>	<p>DIN 1828</p>	<p>6.100</p>		<p>m1-m5</p>
<p>ZVONČASTI KRUŽNI ZUPČASTI NOŽ osnovni profil prema DIN 3972, DIN 5480</p>	<p>DIN 1826</p>	<p>6.101</p>		<p>m1 - m8</p>
<p>PLOČASTI KRUŽNI ZUPČASTI NOŽ osnovni profil prema DIN 3972, DIN 5480</p>	<p>DIN 1825</p>	<p>6.102</p>		<p>m1 - m8</p>

PUŽNA ODVALNA GLODALA sa rupom RADIJALNA i TANGENCIJALNA		6.129		m0.3-m12
PUŽNA ODVALNA GLODALA sa drškom RADIJALNA i TANGENCIJALNA		6.130		m0.3-m1



NAZIV	STANDARD	K.Br.	SLIKA	DIMENZIJA
HSS* HSSE				
PRAVI NOŽVI za grubu obradu sa pločicama od TM	JUS K.C1.051 DIN 4971 ISO 1	7.001		10x10 - 63x40
SAVIJENI NOŽEVI za grubu obradu sa pločicama od TM	JUS K.C1.052 DIN 4972 ISO 2	7.002		10x10 - 63x63
SAVIJENI NOŽEVI za završnu obradu sa pločicama od TM	JUS K.C1.053 DIN 4978 ISO 3	7.003		16x10 - 50x32
PRAVI NOŽEVI za završnu obradu sa pločicama od TM	JUS K.C1.054 DIN 4976 ISO 4	7.004		10x10 - 40x40 20x12 - 50x32
ČEONI NOŽEVI za završnu obradu sa pločicama od TM	JUS K.C1.055 DIN 4977 ISO 5	7.005		16x16 - 50x50
NOŽEVI za bočnu obradu sa pločicama od TM	JUS K.C1.056 DIN 4980 ISO 6	7.006		10x10 - 50x50 20x12 - 50x32
NOŽEVI za odsecanje sa pločicama od TM	JUS K.C.057 DIN 4981 ISO 7	7.007		12x8 - 50x32
NOŽEVI za obradu prolaznih rupa sa pločicama od TM	JUS K.C1.058 DIN 4973 ISO 8	7.008		8x8 - 40x40
NOŽEVI za obradu slepih rupa sa pločicama od TM	JUS K.C1.059 DIN 4974 ISO 9	7.009		8x8 - 40x40

NOŽEVI pravi šiljasti sa pločicama od TM	JUS K.C1.060 DIN 4975 ISO 10	7.010		16x10 - 40x25
NOŽEVI za odsecanje za rad na automatima sa pločicama od TM	JUS K.C1.061	7.011		10x10 - 14x14
NOŽEVI za unutrašnje usecanje sa pločicama od TM	JUS K.C1.062	7.012		10x10 - 32x32
NOŽEVI za spoljni navoj sa pločicama od TM	JUS K.C1.063	7.013		10x10 - 25x16
NOŽEVI za unutrašnji navoj sa pločicama od TM	JUS K.C1.064	7.014		12x12 - 32x32
NOŽEVI ZA GRUBU OBRADU	PSBNR/L	7.041		16x16 50x50
SAVIJENI NOŽ ZA GRUBU OBRADU	PSSNR/L	7.040		16x16 50x50
NOŽEVI ZA ZAVRŠNU OBRADU	PCLNR/L	7.045		20x20 40x40
NOŽEVI ČEONI ZA ZAVRŠNU OBRADU	PTFNR/L	7.038		12x12 40x40
NOŽEVI ZA UZDUŽNU OBRADU	PTGNR/L	7.035		12x12 50x50
NOŽEVI ZA BOČNU OBRADU	PSKNR/L	7.044		12x12 40x40
PRAV ŠILJASTI NOŽ ZA UZDUŽNO STRUGANJE	PSDNN	7.043		12x12 32x32

<p>SPIRALNE BURGJE sa valjkastom drškom sa pločicama od TM za metal, desnorezna</p>	<p>JUS K.D3.040 DIN 8037</p>	<p>7.150</p>		<p>4.0 - 20</p>
<p>SPIRALNE BURGJE sa valjkastom drškom sa pločicama od TM za veštačke materijale desnorezne</p>	<p>JUS K.D3.042 DIN 8038</p>	<p>7.151</p>		<p>4.0 - 20</p>
<p>SPIRALNA BURGIJA sa morze-koničnom drškom sa pločicama od TM, za metal desnorezna</p>	<p>JUS K. D3.041 DIN 8041</p>	<p>7.152</p>		<p>10.0 - 30</p>
<p>SPIRALNA BURGIJA sa valjkastom drškom sa pločicama od TM za kamen i beton desnorezne</p>	<p>DIN 8039</p>	<p>7.153</p>		<p>4.0 - 20</p>
<p>SPIRALNA BURGIJA sa koničnom drškom sa pločicama od TM za kamen i beton</p>		<p>7.175</p>		<p>6.0 - 20</p>
<p>SPIRALNA BURGIJA sa valjkastom drškom sa pločicama od TM</p>	<p>TE10 - T25 HILTI TE17</p>	<p>7.176</p>		<p>6.0 - 20</p>
<p>SPIRALNA BURGIJA sa valjkastom drškom sa pločicama od TM za kamen i beton</p>	<p>T32 - T 72 HILTI</p>	<p>7.177</p>		<p>10 - 35</p>

BURGIJE za duboko bušenje		7.191		3-20
SPIRALNI UPUŠTAČI sa morze-koničnom drškom sa pločicama od TM za metal desnorezni	DIN 8043	7.200		12-40
KONIČNI UPUŠTAČI sa morze-koničnom drškom sa pločicama od TM za metal desnorezni	DIN 8060	7.210		20 - 60
MAŠINSKI NASADNI UPUŠTAČI sa koničnom rupom 1 : 30 sa pločicama od TM, za metal desnorezni	JUS K.D3.342 DIN 8022	7.221		32 - 75
MAŠINSKI NASADNI UPUŠTAČI sa koničnom rupom 1 : 30, dugi, sa pločicama od TM za metal, desnorezni		7.222		32 - 75
MAŠINSKI RAZVRTAČI sa valjkastom drškom pravi žlebovi sa pločicama od TM za metal, desnorezni	JUS K.D3.146 DIN 8050	7.225		6 - 20
MAŠINSKI RAZVRTAČI sa valjkastom drškom dugi pravi žlebovi sa pločicama od TM za metal, A i B	JUS K.D3.147 DIN 8093	7.226		6 - 20
MAŠINSKI RAZVRTAČI sa morze-koničnom drškom pravi žlebovi sa pločicama od TM za metal, desnorezni	JUS K.D3.148 DIN 8051	7.227		8 - 40

<p>MAŠINSKI RAZVRTAČI sa morze-koničnom drškom, dugi sa pločicama od TM za metal, desnorezni</p>	<p>JUS K.D3.149 DIN 8094</p>	<p>7.228</p>		<p>8-40</p>
<p>MAŠINSKI NASADNI RAZVRTAČI sa koničnom rupom 1 : 30, pravi žlebovi sa pločicama od TM za metal desnorezni</p>	<p>JUS K.D3.173 DIN 8054</p>	<p>7.229</p>		<p>32 - 75</p>
<p>MAŠINSKI NASADNI RAZVRTAČI sa koničnom rupom 1 : 30, sa voljicom u produžetku pločice pravi lebovi sa pločicama od TM za metal, desnorezni</p>		<p>7.230</p>		<p>32 - 75</p>
<p>VRETENASTA GLODALA sa valjkastom drškom leva spirala sa pločicama od TM za metal, desnorezna</p>	<p>JUS K.D2.100 DIN 8044</p>	<p>7.300</p>		<p>10 - 25</p>
<p>VRETENASTA GLODALA sa morze-koničnom drškom, leva spirala sa pločicama od TM za metal, desnorezna</p>	<p>JUS K.D2.102 DIN 8045</p>	<p>7.301</p>		<p>12 - 40</p>
<p>GLODALA ZA ŽLEBOVE sa valjkastom drškom sa pločicama od TM za metal, desnorezna</p>	<p>JUS K.D2.120 DIN 8027</p>	<p>7.320</p>		<p>10 - 28</p>
<p>GLODALA ZA ŽLEBOVE sa morze-koničnom drškom, sa pločicama od TM za metal desnorezna</p>	<p>JUS K.D2.122 DIN 8026</p>	<p>7.321</p>		<p>12 - 28</p>

<p>GLODALA ZA T- ŽLEBOVE sa valjkastom drškom sa pločicama od TM za metal desnorezna</p>	<p>JUS K.D2.143</p>	<p>7.330</p>		<p>prečnik 12.5 - 24.5 širina 6 - 14</p>
<p>GLODALA ZA T- ŽLEBOVE sa morze-koničnom drškom,sa pločicama od TM za metal desnorezna</p>	<p>JUS K.D2.144</p>	<p>7.331</p>		<p>prečnik 20.5 - 95 širina 12 - 54</p>
<p>VRETENASTA GLODALA sa valjkastom drškom za tešku obradu sa pločicama od TM za metal, desnorezna</p>		<p>7.340</p>		<p>16 - 32</p>
<p>VRETENASTA GLODALA sa morze-koničnom drškom za tešku obradu sa pločicama od TM za metal, desnorezna</p>		<p>7.341</p>		<p>20 - 63</p>
<p>VRETENASTA GLODALA sa koničnom drškom 7/24 za tešku obradu sa pločicama od TM za metal, desnorezna</p>		<p>7.342</p>		<p>40 - 63</p>
<p>ČEONA NASADNA GLODALA sa pločicama od TM za metal, desnorezna</p>	<p>JUS K.D2.030</p>	<p>7.344</p>		<p>40 - 100</p>
<p>ČEONA NASADNA GLODALA za ravno glodanje sa pločicama od TM za metal, desnorezna</p>	<p>JUS K.D2.031</p>	<p>7.345</p>		<p>40 - 100</p>

KOTURASTA GLODALA sa ukrštenim zubima sa pločicama od TM za metal, desnorezna	JUS K.D2.051	7.346		prečnik 80 - 160 širina 6 - 18
ROTO GLODALA grupa 1, oblik A sa reznim delom od TM	FRA 1 A	7.475		6 - 15
ROTO GLODALA oblik AZ sa čeonim zubima sa reznim delom od TM	FRA 1 AZ	7.476		6 - 15
ROTO GLODALA oblik B, sa reznim delom od TM	FRA 1 B	7.477		6 - 15
ROTO GLODALA oblik C, sa reznim delom od TM	FRA 1 C	7.478		6 - 15
ROTO GLODALA oblik F, sa reznim delom od TM	FRA 1 F	7.479		6 - 16
ROTO GLODALA oblik G, sa reznim delom od TM	FRA 1 G	7.480		6 - 15
ROTO GLODALA oblik H, sa reznim delom od TM	FRA 1 H	7.481		8 - 15
ROTO GLODALA oblik K, sa reznim delom od TM	FRA 1 K	7.482		6 - 15
ROTO GLODALA oblik L, sa reznim delom od TM	FRA 1 L	7.483		6 - 15
ROTO GLODALA oblik O, sa reznim delom od TM	FRA 1 O	7.484		6 - 20
ROTO GLODALA oblik W, sa reznim delom od TM	FRA 1 W	7.485		10 - 15

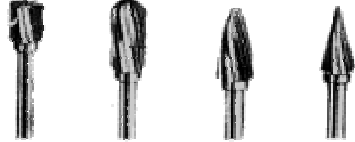
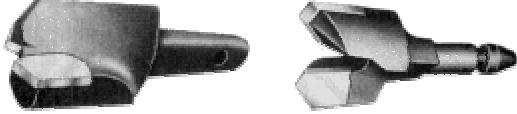
ROTO GLODALA grupa 2 oblik A, C, K, G komplet od TM	FRA 2	7.485		3 - 4
RUDARSKA BURGIJA za dubinsko bušenje sa pločicama od TM		7.550 7.551		36



NAZIV	STANDARD	K.Br.	SLIKA	DIMENZIJA
HSS* HSSE				
GLATKI ČEPOVI dvostrani jednostrani	JUS K.T.3 122 DIN 2245 JUS K.T.3 136 JUS K.T.3 137 DIN 2246/2247	8.001 8.002		1.0 - 50 52 - 120
MERNI TRNOVI za unutrašnji morze konus sa usadnikom	JUS K.T.3 200 DIN 229 JUS K.T.3 202 DIN 230	8.010 8.011		MK C0 - MK C6 MK D0 - MK D6
MERNI ČAURE za spoljni morze konus sa usadnikom	JUS K.T.3 201 DIN 229 DIN 230	8.012 8.013		MK A0 - MK A6 MK B0 - MK B6
GLATKI PRSTENOVI strana "IDE", "NE IDE"	DIN 2250/2254 JUS K.T.3 071 JUS K.T.3 072	8.025		2 - 100
GLATKE RAČVE jednostrane	JUS K.T.3 052	8.030		5 - 120
NAVOJNI ČEPOVI dvostrani za M navoj	JUS K.T.3 173 DIN 2280	8.050		M1 - M48

NAVOJNI ČEPOVI dvostrani za M navoj	DIN 2281 DIN 2283 JUS K.T.3 178 JUS K.T.3 179	8.051		M52 - M68
NAVOJNI ČEPOVI M fini navoj dvostrani jednostani	DIN 2280 DIN 2281/2283 JUS K.T.3 178 JUS K.T.3 179	8.052 8.053		M1 - M48 M52 - M120
NAVOJNI ČEPOVI dvostrani jednostani UNC navoj	~JUS K.T.3 173 ~DIN 2280 ~JUS K.T.3 178 ~JUS K.T.3 179	8.054 8.055		Nr 1-64 - 1 3/4"-5 2"-4.5 - 4"-4
NAVOJNI ČEPOVI dvostrani UNF navoj	~JUS K.T.3 073 DIN 2280	8.056		Nr 0-80 1 1/2"-12
NAVOJNI ČEPOVI G navoj dvostrani jednostani	~JUS K.T.3 173 ~DIN 2280	8.057 8.058		G1/8" - G1 1/2" G1 3/4" - G3 1/2"
NAVOJNI ČEPOVI Tr navoj dvostrani jednostani	DIN 2280 DIN 2281 DIN 2283	8.059 8.060		Tr10 - Tr50 Tr52 - Tr100
NAVOJNI ČEPOVI jednostani usadni nasadni NPT navoj	HANDBOOK H 28	8.061 8.062		1/16" - 1 1/2" 2" - 6"
NAVOJNI ČEPOVI jednostani usadni nasadni R konusni navoj	DIN 2999	8.063 8.064		R1/8" - R1 1/2" R2" - R6"

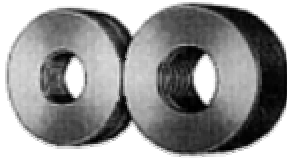
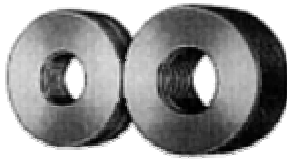
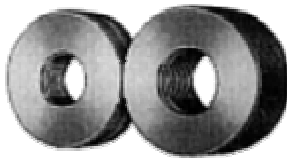
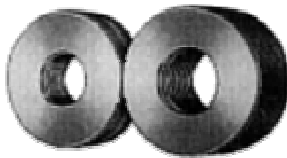
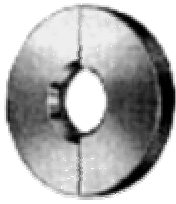
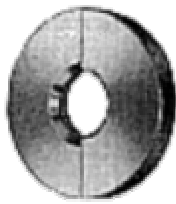
NAVOJNI PRSTENOVI strana "IDE", "NE IDE" M grubi navoj 6g M fini navoj 6g	DIN 2285 DIN 2299 JUS K.T.3 181 JUS K.T.3 182	8.100 8.101		M1 - M68 M1 - M100
NAVOJNI PRSTENOVI strana "IDE", "NE IDE" UNC navoj 2A UNF navoj 2A	DIN 2285 DIN 2299 ~JUS K.T.3 181 ~JUS K.T.3 182	8.102 8.103		Nr1-64 ; 4"-4 Nr0-80 ; 1 1/2"-12
NAVOJNI PRSTENOVI strana "IDE", "NE IDE" G navoj	~DIN 2285 ~DIN 2299 ~JUS K.T.3 181 ~JUS K.T.3 182	8.104		G1/8" - G1 1/4"
NAVOJNI PRSTENOVI strana "IDE", "NE IDE" Tr navoj 7e	~DIN 2285 ~DIN 2299 ~JUS K.T.3 181 ~JUS K.T.3 182	8.105		Tr10 - Tr100
NAVOJNI PRSTENOVI NPT navoj	HANDBOOK H 28	8.106		1/16" - 3 1/2"
NAVOJNI PRSTENOVI R konusni navoj	DIN 2999	8.107		R1/8" - R6"

NAZIV	STANDARD	K.Br.	SLIKA	DIMENZIJA
ALATI za preradu lima prosecanjem		9.001		
ALATI za preradu lima izvlačenjem		9.050		
ALATI za preradu lima savijanjem		9.100		
ALATI za livenje termoplastabrizganjem		9.150		
ALATI za livenje duroplastapresovanjem		9.200		
ALATI za livenje metala		9.250		

<p>ALATI za izradu gumenih delova presovanjem i pečenjem</p>		<p>9.300</p>		
<p>STANDARDNI DELOVI za alate</p>		<p>9.400</p>		



SPECIJALNE BURGIJE

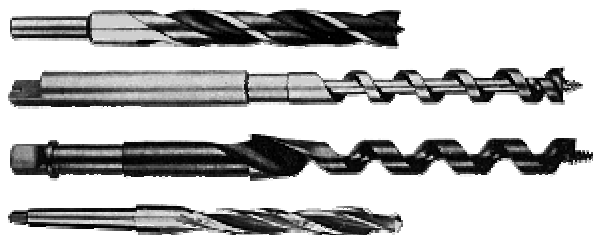

SPECIJALNI RAZVRTAČI I UPUŠTAČI

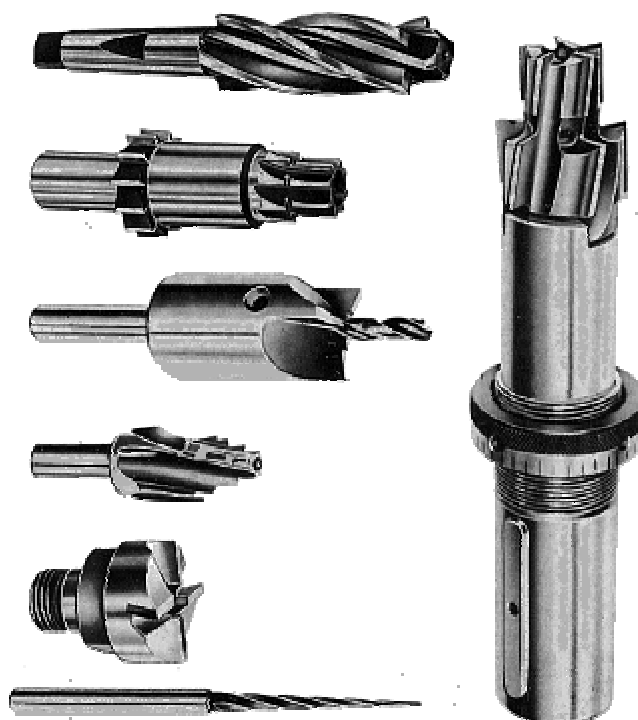

SPECIJALNA GLODALA

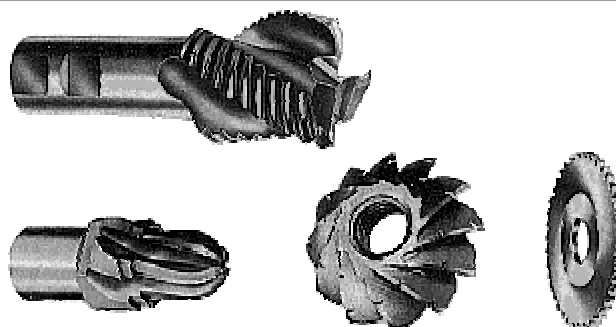

SPECIJALNE UREZNICE

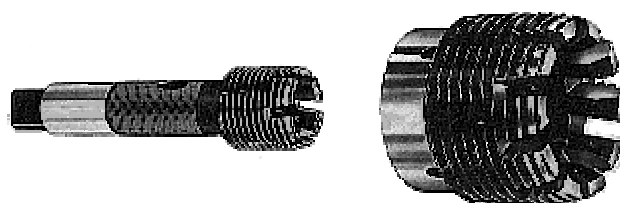

SPECIJALNE NAREZNICE

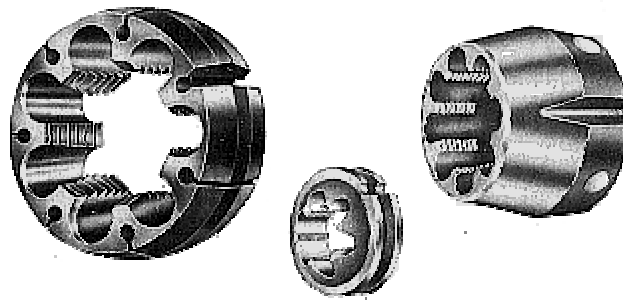

SPECIJALNI ALATI SA PLOČICAMA OD TVRDOG METALA

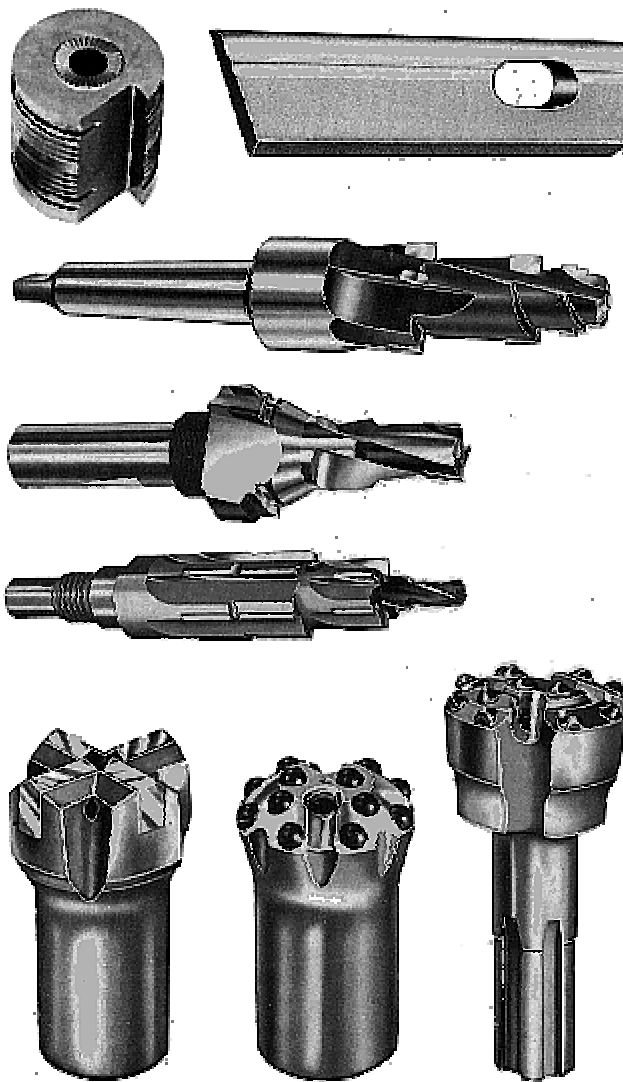

NAZIV	STANDARD	K.Br.	SLIKA	DIMENZIJA
BRZOIZMENLJIVI NOSAČI ZA REZNE ALATE				
BRZOIZMENLJIVE STEZNE GLAVE				
BRZOIZMENLJIVA STEZNA GLAVA BSG-MK	JUS K.G3.055 DIN 228	10.030		BSG 2-BSG 6 MK 2 - MK 6
BRZOIZMENLJIVA STEZNA GLAVA BSG-ISO	DIN 2080	10.031		BSG 2-BSG 5 ISO 40 - ISO 60
BRZOIZMENLJIVI NASTAVAK ZABUŠIVAČA BNZ- d		10.032		BNZ 2 - BNZ 5 2 - 13
BRZOIZMENLJIVI NASTAVAK BRZOSTEZNE GLAVE	DIN 238	10.033		BNB 2 - BNB 4 B 12 - B 16

BRZOSTEZNA GLAVA priključak B-konus priključak UNF- navoj		10.034 10.035		0-4 0-6,5 0-8 0-10 1-13 3-16
BRZOIZMENLJIVI NASTAVAK BNS- MK	JUS M.G0.051	10.036		BNS 2 - BNS 5 MK 1 - MK 5
BRZOIZMENLJIVI NASTAVAK BNS-ČP, ČPK, ČPD		10.037		BNS 2 - BNS 4
BRZOIZMENLJIVI NASTAVAK BNR- MK	JUS M.G0.051	10.038		BNR 2 - BNR 4 MK 2 - MK 4
BRZOIZMENLJIVI NASTAVAK BNP		10.039		BNP 2-1 – BNP 5-4
NOSAČ ZA REZANJE NAVOJA NPDA brzoizmenljivi sa dugim pomeranjem na pritisak i radijalno paralelnim podešavanjem ose		10.051 10.052 10.053		M 2 - M 48 M 2 - M 48 M 2 - M 33
NOSAČ ZA REZANJE NAVOJA NPA brzopromenljivi sa radijalno paralelnim podešavanjem ose		10.057 10.058 10.059		M 2 - M 48 M 2 - M 48 M 2 - M 33

<p>NOSAČ ZA REZANJE NAVOJA NPD-P brzopromenljivi sa dugim pomeranjem na pritisak i povlačenje</p>		10.066 10.067 10.068 10.069		M 2 - M 48 M 2 - M 48 M 2 - M 33 M 2 - M 48
<p>NOSAČ ZA REZANJE NAVOJA N brzopromenljivi</p>		10.070 10.071		M 2 - M 52 M 2 - M 52
<p>NASTAVAK NPM promenljivi sa podešavanjem obrtnog momenta ureznika</p>		10.072		M 2 - M 48
<p>NASTAVAK NPM promenljivi</p>		10.075		M 2 - M 48
<p>NASTAVAK NP-MK promenljivi</p>		10.078		MK 1 - MK 4
<p>NOSAČ NAREZNICE</p>		10.079		M 2 - M 36
<p>GLAVA ZA REZANJE NAVOJA GRNPH sa povratnim hodom sa podešavanjem momenta sigurnosti ureznika, pomeranjem na pritisak i povlačenjem</p>		10.090		GRNPH 1 - GRNPH 2 M 3-12 - M 10-30

GLAVA ZA REZANJE NAVOJA MSP sa podešavanjem momenta sigurnosti ureznika, pomeranjem na pritisak i povlačenjem		10.091		MSP 0 - MSP 4 M 1 - M 68
NOSAČ PODEŠLJIVI PNK za rezne alate, radijalno paralelno podešavanje ose		10.100		MK 1 - MK 4
NOSAČ PODEŠLJIVI PN za rezne alate, radijalno paralelno podešavanje ose		10.101 10.102		MK 1 - MK 4 MK 1 - MK 5
ČAURA PODEŠLJIVA ČPK DIN 6327, kratka		10.105 10.106		MK 0 - MK 4
BRZOIZMENLJIVA NAVRTKA BNP		10.109		Tr 12 × 1.5 do Tr 55 × 2
NOSAČI ALATA ZA OBRADNE CENTRE I CNC MAŠINE				
STEZNE GLAVE sa pripadajućim steznim čaurama po DIN-u 6388 i DIN-u 6499	DIN 69871	10.201		2 - 50
NOSAČI ALATA	DIN 69871	10.203		6 - 32

NOSAČ BRZOSTEZNE GLAVE		10.211		SK 30 - 50
NOSAČ GLODALA SA UZDUŽNIM I POPREČNIM KLINOM	DIN 69871	10.206		16 - 40
RUČICA PODMETAČ VIJAK		10.207		
NOSAČ ZA ALATE sa konusom i navojom na kraju	DIN 69871	10.210		
EKSCENTAR GLAVA ZA RAZBUŠIVANJE EG-2, EG-3		10.216 10.217		50 - 75 70 - 100
NOSAČ ALATA ZA NC/CNC MAŠINE	DIN 69880			16 - 80
POMOJNI PRIBOR				
DUGI TRNOVI za glodala sa jednom vodicom		10.250		
KRATKI TRNOVI za glodala sa MK držkom sa uzdužnim klinom		10.252		

KRATKI TRNOVI za glodala sa konusom 7/24 sa uzdužnim žlebom		10.253		
KRATKI TRNOVI za glodala sa konusom 7/24 sa poprečnim žlebom		10.254		
KRATKI TRNOVI za glodala sa MK drškom sa poprečnim žlebom		10.255		
STEZNE ČAURE NA POTISAK	DIN 6343	10.300 do 10.308		3 - 100
DONOSNE ČAURE	DIN 6344	10.309 do 10.314		10 - 90
STEZNE ČAURE ZA STRUGOVE I BRUSILICE	DIN 6341	10.315 do 10.318		3 - 27
STEZNE ČAURE ZA STEZNU GLAVU	DIN 6388	10.319 do 10.324		2 - 160
STEZNE ČAURE konične		10.325 do 10.328		2 - 26

STEZNE ČAURE ZA VIŠEVRETENE AUTOMATE I MAŠINE ZA NAVOJ		10.363		1,6 - 8,5
REDUCIR ČAURE MK / MK	DIN 2185	10.350		MK 2/1 - MK 6/5
REDUCIR ČAURE MK / MK	DIN 2187	10.351		MK 1/1 - MK 6/5
REDUCIR ČAURE ISO / MK		10.353		SO 30 - ISO 50 MK 1 - MK 5
REDUCIR ČAURE ISO / MK	DIN 6364	10.355		ISO 30 - ISO 60 MK 1 - MK 6
ŠILJCI sa punim vrhom tip A sa pola vrha tip B ravni za izbijanje tip C	JUS K.G3.3	10.400 10.401 10.406		MK 0 - MK 6
PEČURKASTI ŠILJAK		10.407		MK 0 - MK 6
ŠILJCI tip T sa punim vrhom i umetkom od TM-K20 sa pola vrha od TM	JUS K.G3.3	10.402 10.403		MK 1 - MK 6

KRUNICE		10.404		10 - 44
KRUNICE		10.405		6 - 120
OKRETNI ŠILJAK	JUS K.G3.366	10.414		MK 1 - MK 6
OKRETNI ŠILJAK SA PROMENLJIVIM VRHOM		10.415		MK 2 - MK 6
ČEONI OKRETAČ		10.418		MK 3 - MK 6
PODEONA GLAVA I KONJI		10.500		
PUŽNI SPREGOVI		10.525		

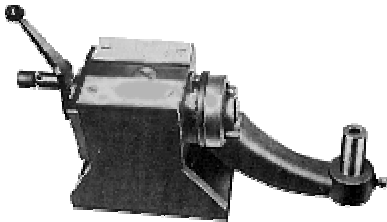
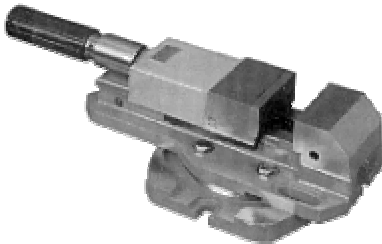
<p>UREĐAJ za merenje podele i grudnog ugla na višesečnom alatu</p>	<p>10.550</p>		
<p>UREĐAJ za merenje osnovog rastojanja puža i pužnog točka MOR</p>	<p>10.551</p>		
<p>UREĐAJ za radijalno profilisanje tocila</p>	<p>10.552</p>		
<p>ZAVOJNA VRETENA SA KUGLICAMA</p>	<p>10.001</p>		<p>D 16 - 80 L do 4000</p>
<p>MONTAŽNI STEZNI PRIBOR I ELEMENTI ZA BAZIRANJE I STEZANJE</p>	<p>10.025</p>		
<p>HIDRAULIČNA STEGA</p>	<p>10.026</p>		<p>MXC - 0 MXC - 1 MXC - 2 MXC - 3</p>
<p>PRECIZNE MAŠINSKE STEGE brzohodna stega - BS kombinovana stega - K Ssinusna uzdužna stega-SUS150 sinusna poprečna stega-SPS 70 sinusna kombinovana-SKS150</p>	<p>10.027</p>		

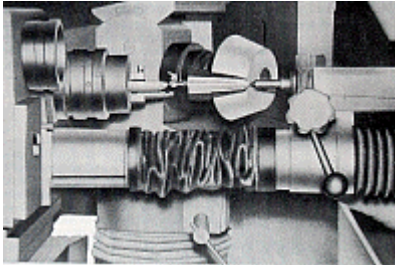
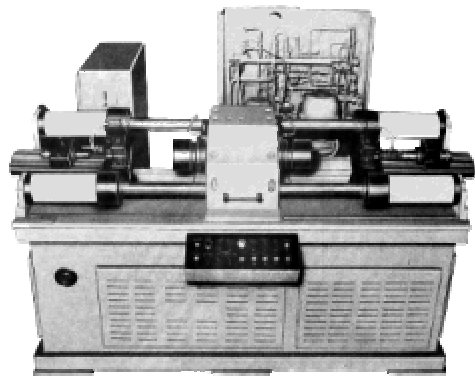
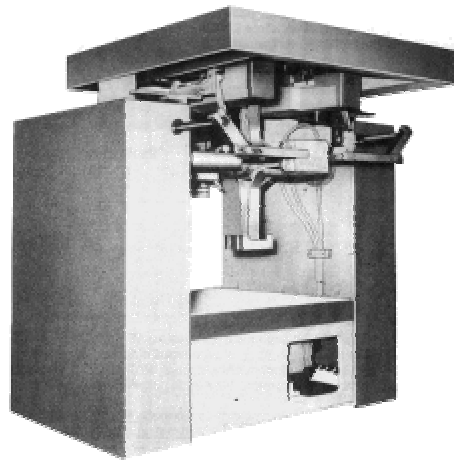
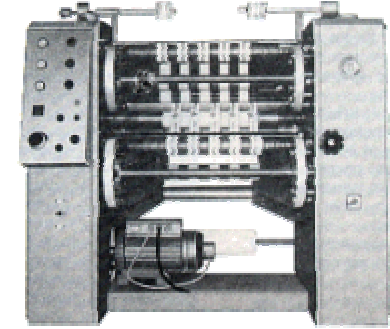
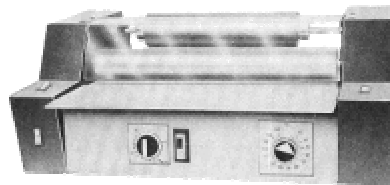
NAZIV	K.Br.	SLIKA
<p>MAŠINA ZA RADIJALNO - AKSIJALNO PODBRUSIVANJE</p>	<p>11.050</p>	
<p>MAŠINA ZA ZAVARIVANJE TRENJEM</p>	<p>11.001</p>	
<p>MAŠINA ZA PAKOVANJE</p>	<p>11.200</p>	
<p>MAŠINA ZA SEČENJE I NAMOTAVANJE</p>	<p>11.250</p>	
<p>MAŠINA ZA PLASTIFICIRANJE PAPIRA</p>	<p>11.350</p>	



Fabrika reznog alata

Adresa:

Hajduk Veljkova 37 - 32000 Čačak – Serbia

Telefon:

Marketing: +381(0) 32 221788

E-mail:

Marketing: export@fra.co.rs

Tehnička podrška: pavle.nikitovic@fra.co.rs